

PH04 COMFORT XLT™ SERIES

PRODUCT INSTRUCTIONS
STATIC MODEL



POLYJOHN®
there when you need us



NOTE: We recommend reading through the entire Assembly Instructions prior to proceeding with installation, service or maintenance. All references to left and right throughout this guide are as viewed from the front.

PRODUCT SPECIFICATIONS

COMFORT XLT™ SERIES
PH04-1000



DIMENSION	IMPERIAL	METRIC
Exterior Height	91 in	231 cm
Exterior Width	62 in	157 cm
Exterior Length	62 in	157 cm
Door Frame Height(I.D.)	74 in	188 cm
Door Frame Width(I.D.)	32 in	81 cm
Tank Seat Height	19 in	48 cm
Weight	240 lb	108 kg
Static Tank Capacity	60 gal	227 L
Side Panel Decal Area	12" x 23"	30cm x 58cm
Door Panel Decal Area	27" x 27"	68cm x 68cm

PRODUCT OVERVIEW

COMFORT XLT™ SERIES
PH04-1000

THE COMFORT XLT® – XTRA LARGE TANK

PolyJohn's Comfort XLT portable toilet features all-new interior components PROs have been asking for. Designed with a large tank (capacity of 60 gallons) and a sloped, smooth tank top for easy cleaning, this unit is ideal for special events of all types including weddings, concerts, fairs, festivals, construction sites and parties where guests just want extra room.

The Comfort XLT provides many ease-of-use features including:

- Oversized, self-closing door
- Roll-in ground level floor access
- Optional interior handrails. If desired, please order 3 of part number PH03-0020 for a unit without sink or 1 of PH03-0020 and 2 of PH04-0020 for units with sink. A PH04-0201 small parts bag has all the fasteners needed.

READ FIRST: Please follow directions in the sequence they are presented. It is suggested you read through the entire assembly instructions prior to proceeding.

- Proper handling is required, especially structures that have flat floors with minimal foundations. Dropping this unit during transport and site set-up may cause structural damage or misalignment of the front assembly and door.
- Position on clear level ground, shims may be used under the floor to aid in leveling, or the door may be out of alignment.
- The PH04 Model restroom assembly will require two people.
- All drilling with 13/64" and 1/4" drill bits. All rivet holes drilled 13/64" dia.

TOOLS REQUIRED FOR ASSEMBLY



Drill



13/64" Drill Bit



1/4" Drill Bit



Awl



Rivet Gun

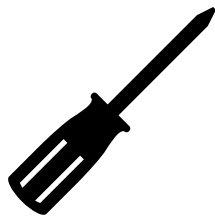

Phillips & Slotted Screwdriver



Hammer



Tape Measure



Socket Wrench

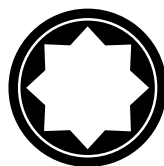

7/16" Socket



Vice Grips

FULL SIZE SCALE FASTENER DRAWINGS

COMFORT XLT™ SERIES
PH04-1000

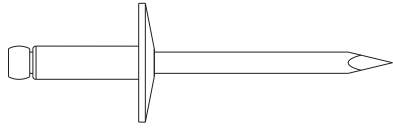

(113) PC-000100 Rivet
Large Flange, Short

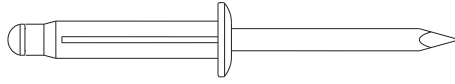

(12) PC-000105 Rivet
Small Flange

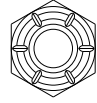

(30) PC-000140
Nut 1/4"-20 Nylok

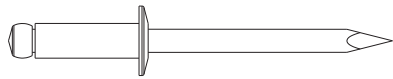

(2) PC-000102 Rivet
Small Flange, Short

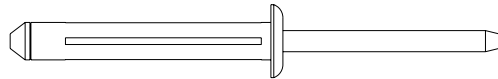

(1) PC-000117 Rivet
Hollow Wall 3/4" Grip

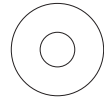

(121) PC-000106 Washer
3/16" Back-up

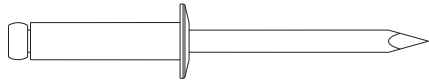

(2) PC-000104 Rivet
Small Flange, Long

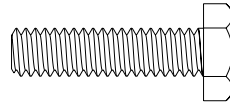

(23) PC-000139 Bolt
1/4"-20 x 1" Hex Head

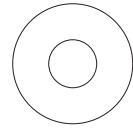

(30) PC-000123 Washer
1/4" x 5/8" Flat

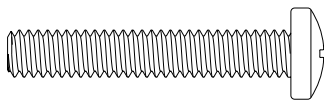

(6) PC-000175 Screw
1/4"-20 x 1-1/2" Phillips

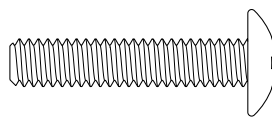

(1) PC-000174 Bolt
1/4"-20 x 1-1/4" Hex Head

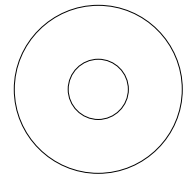

(1) PC-000168 Washer
5/16" x 7/16" Flat

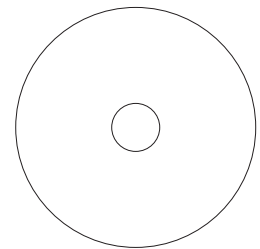

(23) PC-000121 Washer
1/4" x 1-1/4" Fender

ASSEMBLY INSTRUCTIONS

COMFORT XLT™ SERIES
PH04-1000

STEP 1: PREPARE THE BASE SURROUND FOR ATTACHING THE WALL PANELS

Drill a 1/4" hole in center notch of base surround for mounting, centering, and leveling the first side panel. This will be repeated for other two side panels.

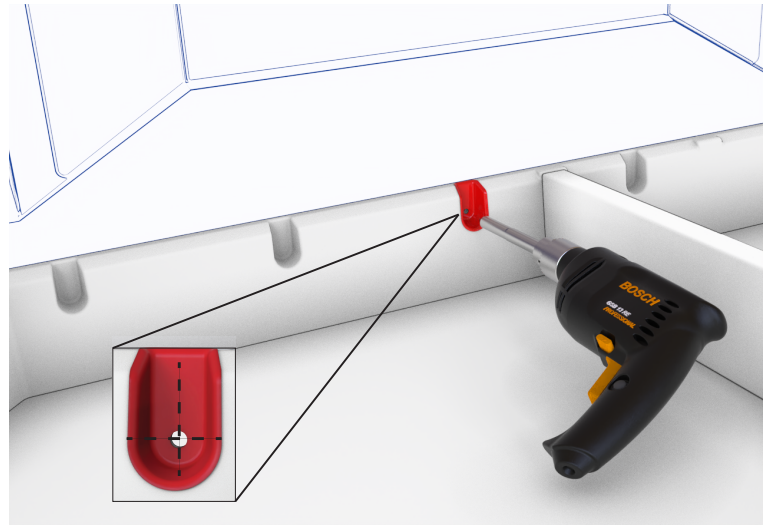

STEP 2. THREE WALL PANELS AND FOUR CORNER MOLDING SUB-ASSEMBLY

Locate three wall panels and four corner panels. Choose one of the wall panels to be the rear panel and add a corner molding to each side of the rear panel wall using (9) PC-000100 rivets and (9) PC-000106 back-up washers. Rivet in the center holes first, then to the top, and back down to the bottom. Follow this procedure for both of the side wall panels connecting them to both rear corners. Repeat, as well for both of the front corner moldings. NOTE: (Make sure to rivet corner moldings from the outside in, this gives a good visual appearance.) Lift the three wall panels and four corner moldings sub-assembly and wrap them around the base, resting the corners on the 1/4" raised areas molded into the top of the base.

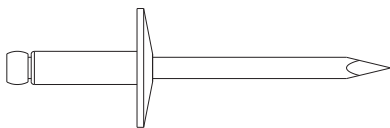

PC-000100 Rivet
54 Used in this step

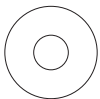

PC-000106 Washer
54 Used in this step

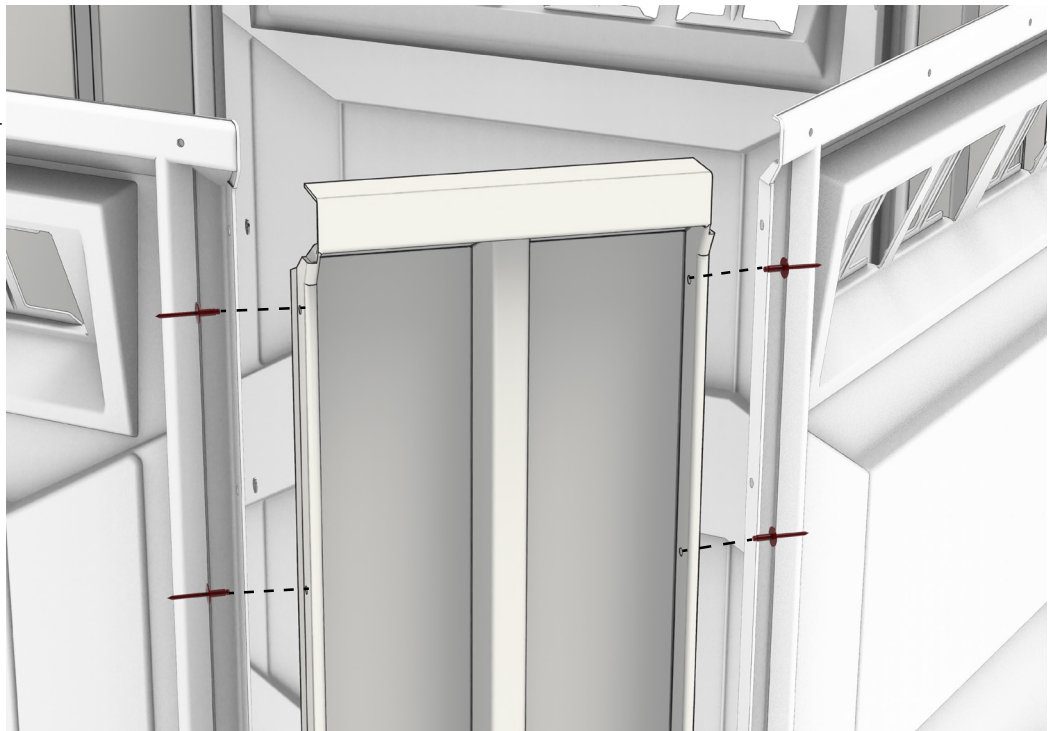

ASSEMBLY INSTRUCTIONS

COMFORT XLT™ SERIES
PH04-1000

STEP 3: ATTACH THE WALL PANELS TO THE BASE SURROUND

Place a PC-000121 washer on a PC-000139 bolt and insert the bolt through the center hole in the left side panel and into the base surround. Place a PC-000123 washer on the inside along with a PC-000140 nut and tighten. Repeat this step for the other two side panels. Level the left side panel, and using the remaining holes in the side as a guide, drill 1/4" holes all the way through the base surround. Fasten the side to the base using the same method as for the center hole. Repeat this for the rest of the sides.



CABANA WRAPPED AROUND BASE SURROUND

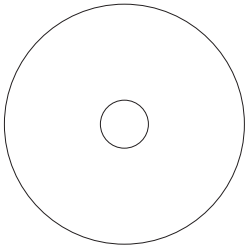

PC-000121 Washer
15 Used in this step

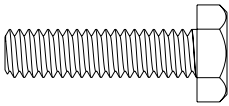

PC-000139 Bolt
15 Used in this step



PC-000140 Nut
15 Used in this step

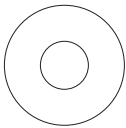

PC-000123 Washer
15 Used in this step

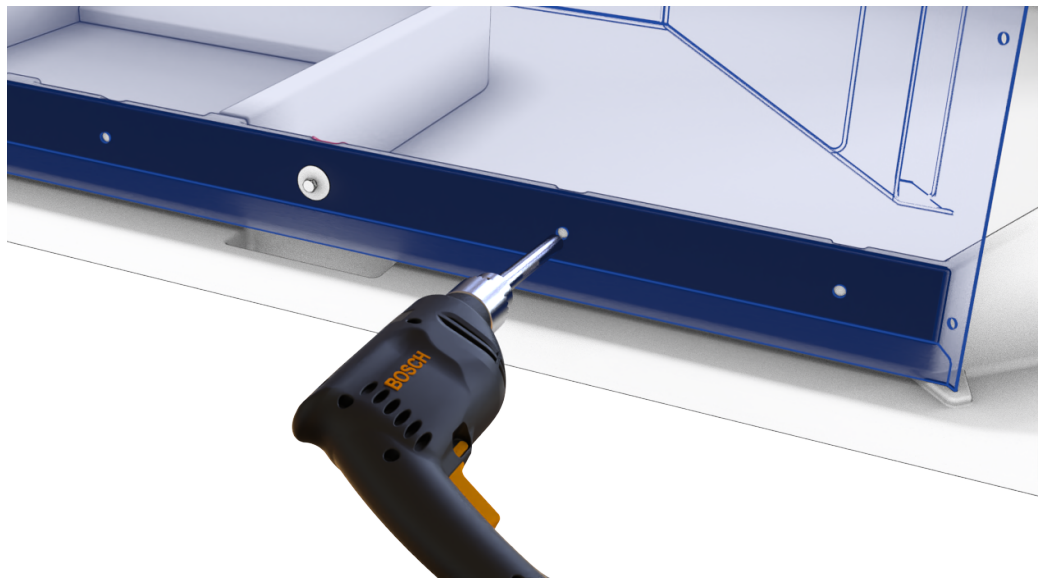

ASSEMBLY INSTRUCTIONS

COMFORT XLT™ SERIES
PH04-1000

STEP 4. FRONT SUB-ASSEMBLY TO THE BASE SURROUNDS

Lift the front sub-assembly and place the legs of the aluminum door jamb into the front of the base surround on each side of the door opening. Attach the front assembly to the front corner moldings by riveting into the pre-drilled holes using (18) PC-000100 rivets and (18) PC-000106 back-up washers as in Step 1. NOTE: (Make sure that you rivet from the outside of the front toward the corner.) For shipping purposes, there is a zip tie holding the holding the door closed with the front assembly. Cut this tie off and install a PC-000104 rivet into the hole in the door jamb. Grab one side of the front assembly and pull tightly into the "pocket" of the base surround and place a pair of vise-grips onto the base surround holding the front sub-assembly. Locate the three pre-drilled holes in the bottom of the door jamb, using a 1/4" drill bit, drill into those holes all the way through the base surround. Fasten the jamb to the base surround using (3) PC-000175 screws with (3) PC-000123 washers with (3) PC-000140 lock-nuts. Be careful not to over tighten the bolts, crushing the base surround. Repeat this for the other side of the front sub-assembly. **Be careful not to over tighten the bolts, crushing the base surround.**

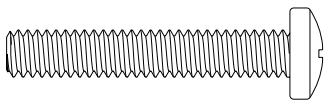

PC-000175 Screw
6 Used in this step

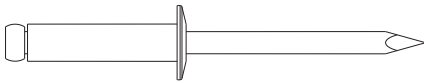

PC-000104 Rivet
1 Used in this step

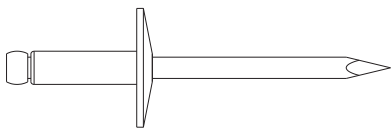

PC-000100 Rivet
18 Used in this step

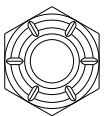

PC-000140 Nut
6 Used in this step

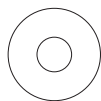

PC-000106 Washer
18 Used in this step

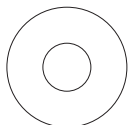

PC-000123 Washer
6 Used in this step

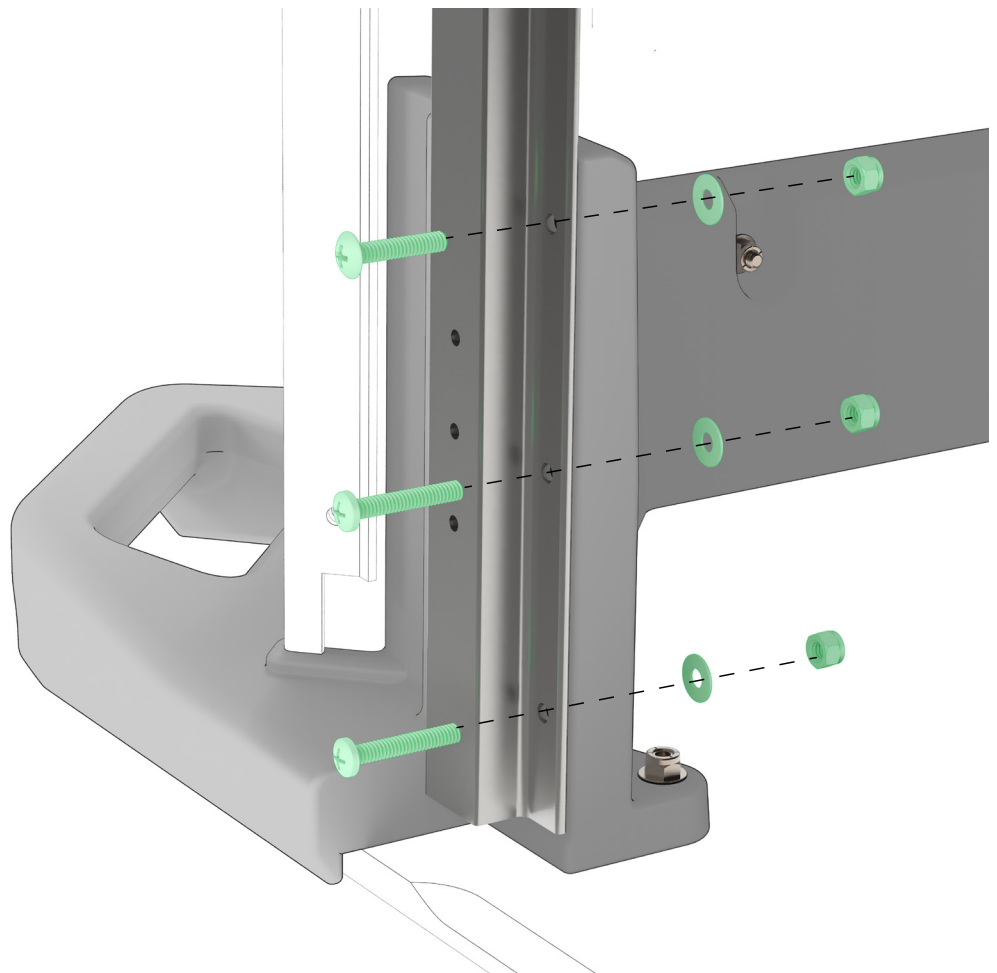

ASSEMBLY INSTRUCTIONS

COMFORT XLT™ SERIES
PH04-1000

STEP 5: ATTACHING CORNER MOLDINGS TO THE BASE SURROUND

For the corner moldings: NOTE: (Be sure the corners are pushed tight against the base surround by pushing the corner at the rib in the center.) Start with the front corners first. From the inside of the unit, locate the two recesses in the front inside corners of the base surround. Drill a 1/4" hole through the centers of these recesses and through the corner panel. Fasten in place using the PC-000121 washers and PC-000139 bolts on the outside with the PC-000123 washers and PC-000140 nuts on the inside. Tighten in place. Repeat these steps for the remaining corner panels.

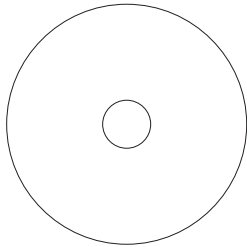
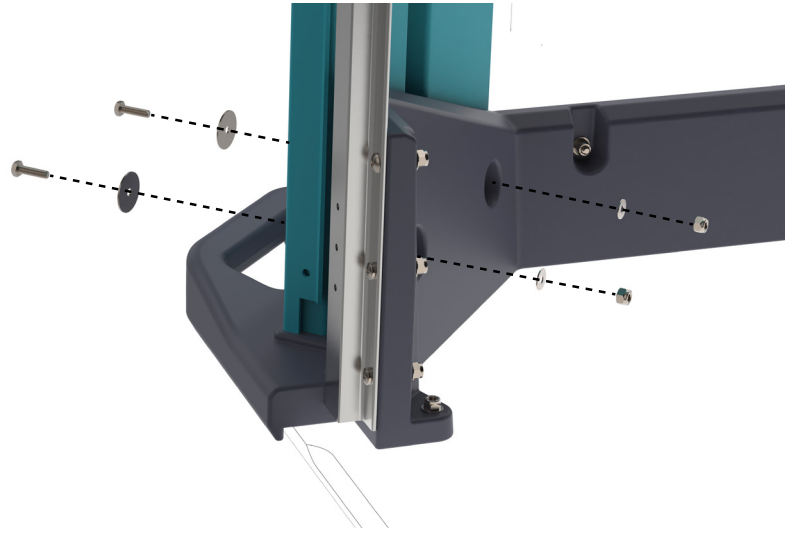

PC-000121 Washer
8 Used in this step

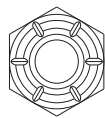

PC-000140 Nut
8 Used in this step

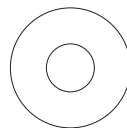

PC-000123 Washer
8 Used in this step

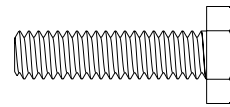

PC-000139 Bolt
8 Used in this step

STEP 6. ROOF ASSEMBLY

NOTE: (The front and three wall panels are supplied with pre-drilled holes at the top center of each panel. The roof is supplied with dimple spots along each of the eight edges.) Use a 13/64" drill bit. Drill holes in the center dimple spots of the roof. **IMPORTANT - BE SURE TO ALIGN THE HOLE FOR THE VENT STACK IN THE ROOF WITH THE HOLE IN THE TANK.** Start with the front of the unit: The roof needs to be aligned with the center hole in the jamb. When aligning the roof to the front assembly, apply pressure to the left corner molding, this will cause the door to move up and down within the aluminum door jamb. Before installing the rivets in this area square up the door to the jamb. Someone on the outside will rivet PC-000100 rivets through each of the four center holes of the roof to the wall panels, while another person places PC-000106 back-up washers on the rivet stems from inside the unit. Proceed with the corner moldings: Using a 13/64" drill bit, drill holes in the center on both sides of the rib and then rivet into place as above. For the wall panels: Hold the roof firmly against the wall panels. Using a 13/64" bit, drill through the remaining dimple spots of the roof into the wall panels. The person on the outside will again rivet the PC-000100 rivets through the drilled holes, while from inside, someone will place PC-000106 back-up washers on the rivet stems.

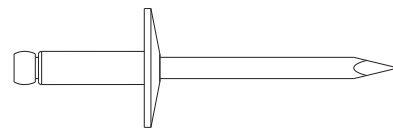

PC-000100 Rivet
28 Used in this step

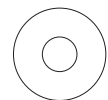

PC-000106 Washer
28 Used in this step

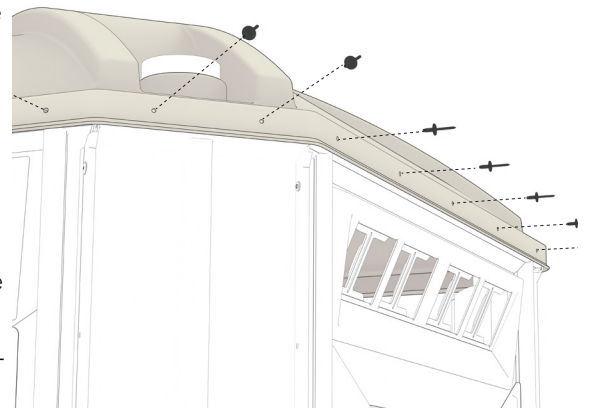

ASSEMBLY INSTRUCTIONS

COMFORT XLT™ SERIES
PH04-1000

STEP 7. WASTE TANK INSTALLATION

On the outside of the unit measure and mark drill spots. All holes will be 17-3/4" up from the top of the base surround. For the rear wall panel make a mark above each 'corner' in the bottom rib. Make another mark half way between those two. For the corner molding, make a mark on each side of the center rib, right in the middle. On the left wall panel, make a mark above the 'corner' of the bottom rib and another 13-1/2" towards the front. Position the waste tank in the left rear corner on the tank supports of the base surround. While inside one person holds the tank in the proper position, using a 13/64" bit, someone on the outside will drill through the 7 spots just marked. **CAUTION: WHEN DRILLING HOLES, ESPECIALLY THE REAR PANEL, BE SURE TO DRILL ONLY THROUGH THE FIRST WALL OF THE TANK.** Place a PC-000106 back-up washer on the body of the PC-000105 rivet and rivet in place. Repeat this for the remaining 6 holes.

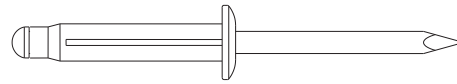
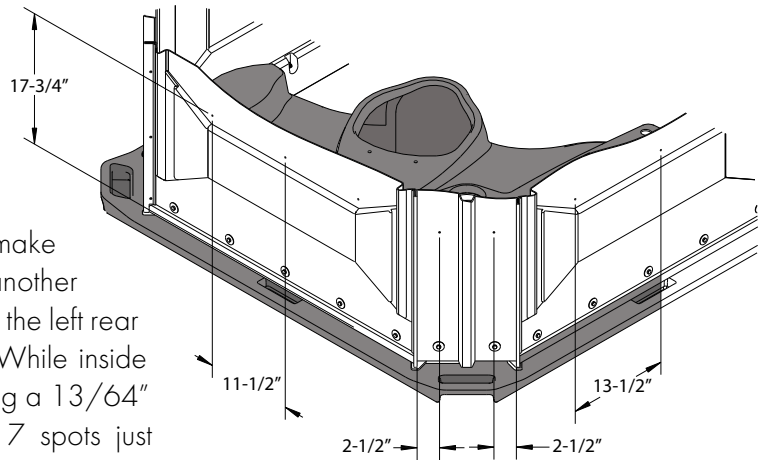

PC-000105 Rivet
7 Used in this step

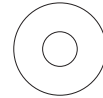

PC-000106 Washer
7 Used in this step

STEP 8. FLY SCREEN INSTALLATION

Each of the three sidewall panels has two vent screens. On the surface of each screen there is a date stamp symbol. The symbol goes toward the center of the sidewall panel, facing the inside. For each of the sidewalls, insert into the vent slot one screen from each side and overlap the center holes of the screens (at the date stamp symbol). **IMPORTANT - MAKE SURE BOTH SCREENS ARE CENTERED IN THE VENT SLOT.** From inside the unit using a 13/64" drill bit, drill a hole through the center hole of the screen and into each of the side walls. From the outside rivet a PC-000100 rivet into the center hole with a PC-000106 back-up washer on the inside. From inside the unit using the holes at the ends of the screens as guides, drill holes through to the wall panels. From the outside rivet the screens in place with PC-000100 rivets and PC-000106 back-up washers on the inside.

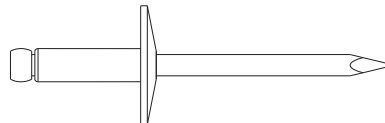
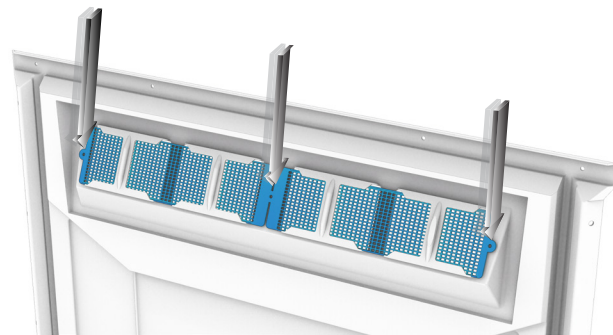

PC-000100 Rivet
9 Used in this step

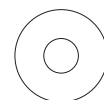

PC-000106 Washer
9 Used in this step

STEP 9. VENT STACK INSTALLATION

Slide the vent stack up through the 4" hole of the roof and down into the corresponding hole in the tank. Using a 13/64" drill bit, drill a hole through the boss on the tank and through the vent stack. Rivet into place with (1) PC-000117 rivet.

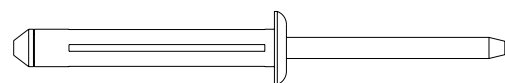

PC-000117 Rivet
1 Used in this step

ASSEMBLY INSTRUCTIONS

COMFORT XLT™ SERIES
PH04-1000

STEP 10. ROTARY LATCH

Place the door handle PC-000576 such that the edge of the opening in the door catches the hinge points on the handle. When the handle is in place, insert the screw PC-000174 through the handle's center mounting hole. Take the rotary latch, PC-000575C, and place it in the door opening from the backside of the door. Guide it on to the screw. Use washer PC-000123 and nut PC-000140 to fasten the two halves together. Adjust the tightness of the screw to adjust the ease of the latch movement.

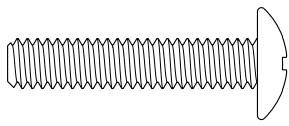
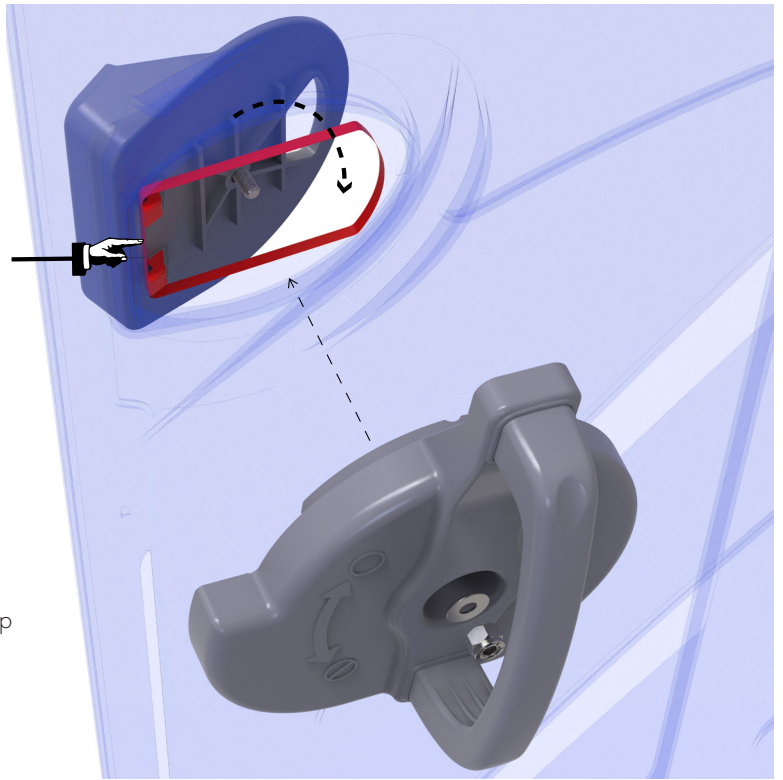

PC-000174 Bolt
1 Used in this step



PC-000140
1 Used in this step

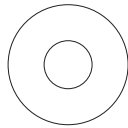

PC-000123 Washer
1 Used in this step

STEP 11. DOOR CHECK CABLE

Align the three holes of the metal bracket on the door check cable to the holes in the top inside center of the door so that the bracket angles toward the unit and the three holes line up with the holes in the bracket (as shown). Rivet into place using (3) PC-000105 rivets. From the outside of the unit, insert a PC-000104 rivet into the pre-drilled hole at the top of the door opening of the door jamb. Place the looped end of the door check cable on the end of the rivet followed by (1) PC-000168 washer and (1) PC-000106 back-up washer. Rivet in place.

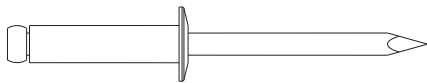

PC-000104 Rivet
1 Used in this step

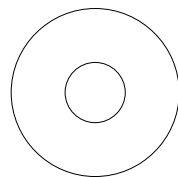

PC-000168 Washer
1 Used in this step

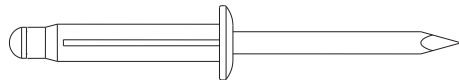

PC-000105 Rivet
3 Used in this step



PC-000106 Washer
1 Used in this step

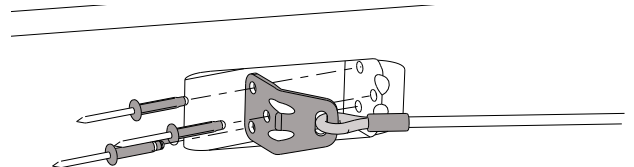

STEP 12. TOILET SEAT INSTALLATION

Place the toilet seat on the top of the tank. Line up the holes in the hinge of the seat with the holes in the top of the tank. Insert the seat bolts through the seat hinge and through the tank. Lift open the seat, thread the plastic seat nuts on the ends of the bolts and tighten.

ASSEMBLY INSTRUCTIONS

COMFORT XLT™ SERIES
PH04-1000

STEP 13. TOILET PAPER DISPENSER

The double roll dispenser can be mounted in a location of your preference based upon the accessories you have in the unit. Level the dispenser on the wall and use the four holes in the back of the dispenser as a guide to mark the location for drill holes. Drill four 13/64" holes into the drill spots just marked. From outside of the unit, rivet in place using (4) PC-000100 rivets and (4) PC-000106 back-up washers on the inside.

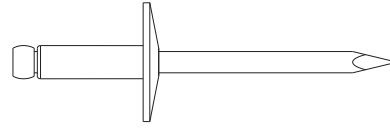

PC-000100 Rivet
4 Used in this step

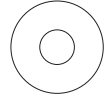

PC-000106 Washer
4 Used in this step

STEP 14. DOOR CLOSURE INSTALLATION

Push the spring tube assembly into the hole in the center molded pocket of the door with the cable end towards the hinged side of the door. Insert the tabs of the door closure retainer clip into the 2 pre-drilled holes as shown below. Pivot the retainer clip into place while feeding the spring cable through the hole in the retainer clip. Rivet into place with (2) PC-000105 rivets. Line up the cable clip in the center of the door jamb to the door closure retainer clip. From inside the unit using a 13/64" bit, drill two holes into one side of the door jamb only. Rivet the cable clip to the door jamb using (2) PC-000102 rivets. On the inside of the unit, place the top of a hammer against the cable clip. Place the barrel end of the spring cable in the claw of the hammer. Open the door while holding the hammer in position. Hold the door open with your foot and clamp a vice-grip pliers on the cable where it comes out of the door. BE SURE TO CLAMP DOWN TIGHT. Remove the cable from the claw of the hammer, close the door and place the end of the cable into the slot of the cable clip. Open the door and remove the vice-grips.

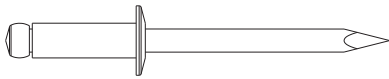

PC-000102 Rivet
2 Used in this step

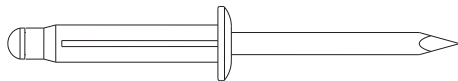
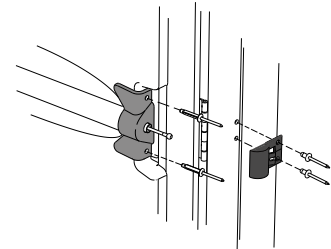
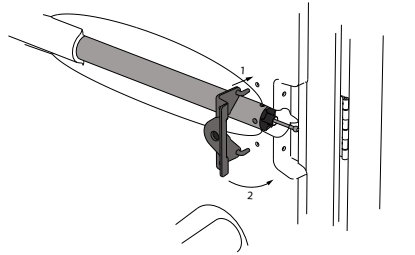

PC-000105 Rivet
2 Used in this step

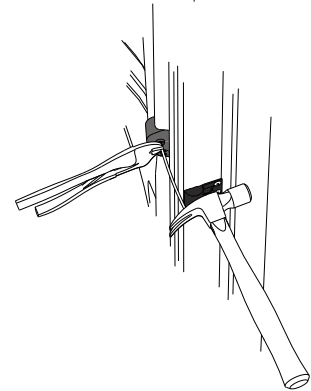
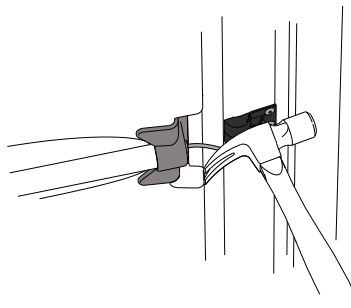

STEP 15. OPTIONAL URINAL INSTALLATION

Insert the drain spigot of the urinal into the hole on the left top surface of the holding tank. Position the urinal so that it is level. There are two holes at the top of the urinal. Drill 13/64" holes through those holes and through the side wall panel. From outside of the restroom one person will rivet through the drilled holes with PC-000102 rivets, while another person inside the restroom places PC000106 back-up washers on the rivet stems.

PARTS DIAGRAM

COMFORT XL™ SERIES PH04-1000

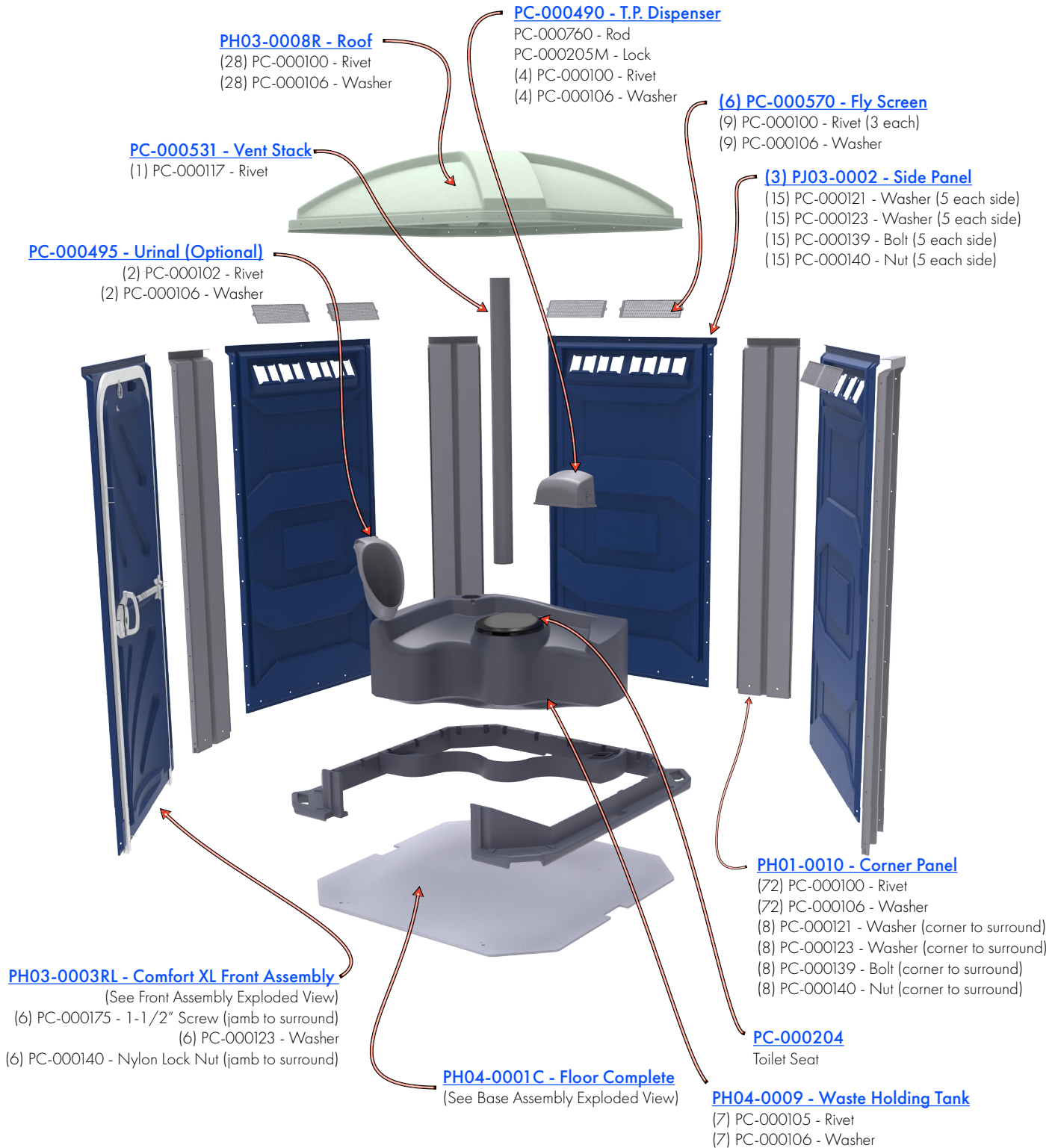

PARTS DIAGRAM FRONT ASSEMBLY

COMFORT XLT™ SERIES
PH04-1000

PH03-0003RL - Front Assembly w/ *Small Parts

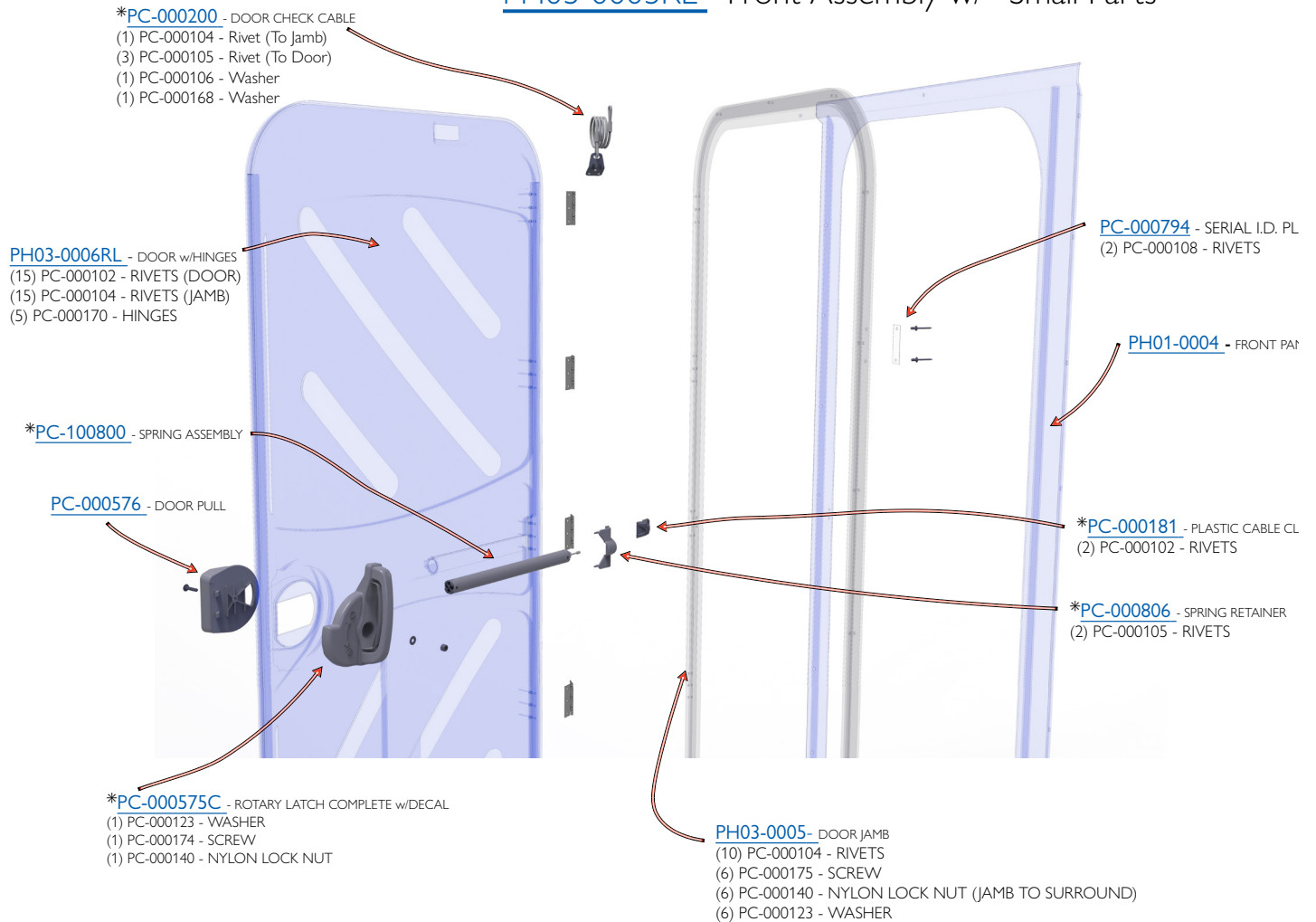

PARTS DIAGRAM BASE ASSEMBLY

COMFORT XLT™ SERIES
PH04-1000

CXLT BASE COMPLETE

PH04-0001C - STATIC TANK/HAND FLUSH TANK

PH04-0001CF - FOOT FLUSH TANK

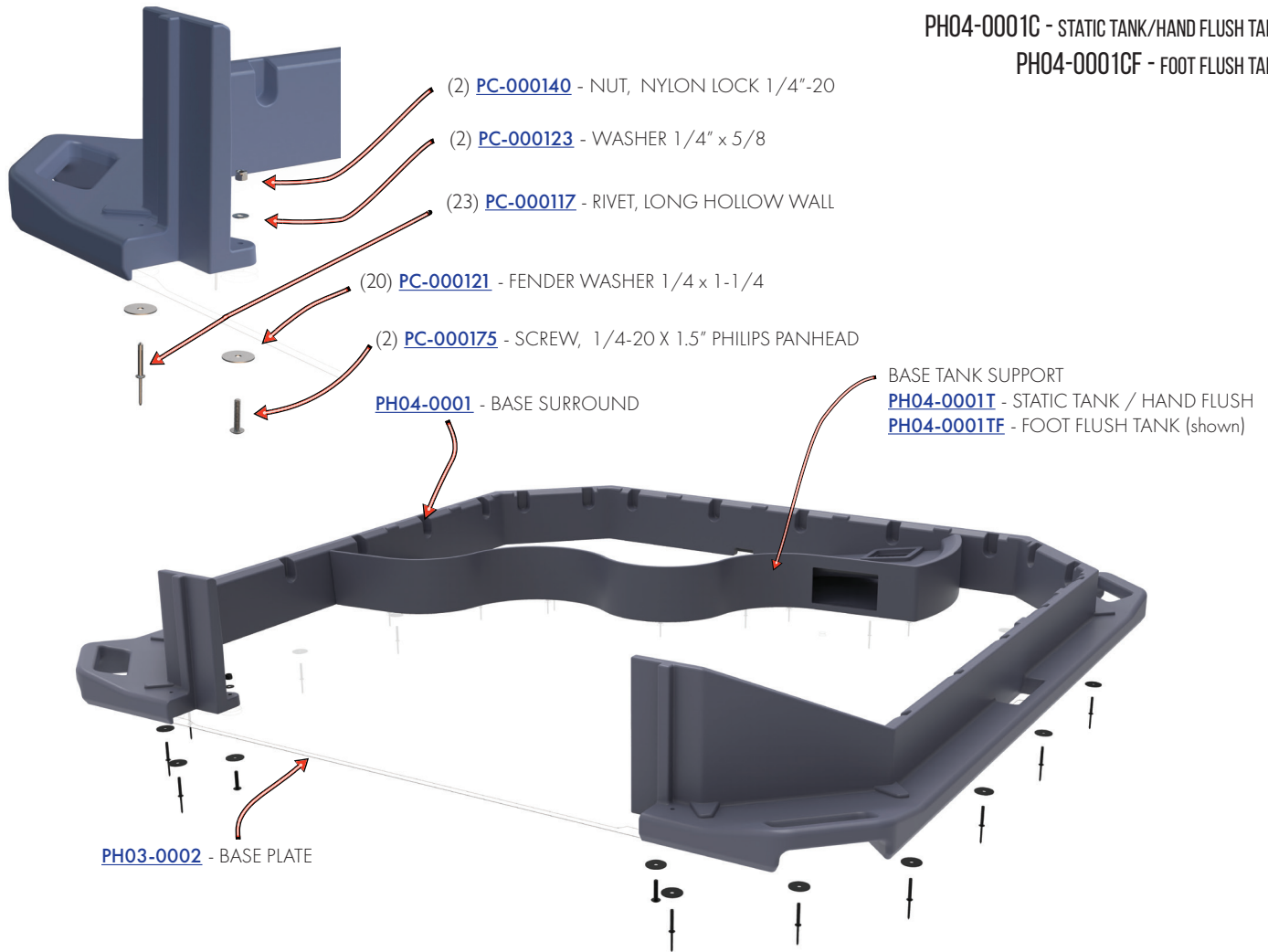

OPTIONAL ACCESSORIES, SUPPLIES AND CHEMICALS

COMFORT XLT™ SERIES
PH04-1000



Liquid Hand Sanitizer
PSD1-1000



Bulk Hand Sanitizer
CKHS-0004



Deodorizing Packages

CLEANING AND MAINTENANCE

Use a mild soap to clean all surfaces and component parts.

Minor scratches and abrasions can be lightly sanded or scrubbed with a mild abrasive cleaner (such as "Soft Scrub") that contains calcium carbonate, hypochlorate bleach, and detergents. Be sure to follow the cleaning product directions since these ingredients may cause hazardous gases when mixed with other chemicals. Rinse the cleaned areas and buff with a conventional wax.

Some light scratches may also be hidden by using an industrial hot air gun.

For a source of cleaning, deodorizing and paper products contact:

**PRO'S CHOICE
2500 GASPAR AVE.
WHITING, IN 46394-2175
800-292-1305
www.polyjohn.com/supplies/pros-choice.html**

We highly recommend membership in the Portable Sanitation Association International (PSAI); the worldwide authority on portable sanitation services. The PSAI, "Portable Sanitation Industry Certification Program" manual contains a wealth of information on standards and service procedures. For more information contact the PSAI:

**PORTABLE SANITATION ASSOCIATION INTERNATIONAL (PSAI)
7800 METRO PARKWAY, SUITE 104
BLOOMINGTON, MINNESOTA 55425 USA
800-822-3020 / 612-854-8300 FAX 612-854-7560
www.pσαι.org**

Prop 65

PolyJohn Corporation would like to inform any customers or end users that some products may contain chemicals listed in California's Safe Drinking Water & Toxic Enforcement Act of 1986. Commonly referred to as Proposition 65, this Act establishes a list of chemicals known by the State of California to present a risk of cancer, birth defects, or other reproductive harm.

Chemical exposure typically occurs through inhalation, ingestion, or adsorption. PolyJohn products are not intended to be used in these methods. PolyJohn Corporation cannot foresee all uses of their products (both intended and unintended uses) and as a result has opted to provide a general warning of known chemical presence.

The Proposition 65 chemical list can be found at <http://www.P65Warnings.ca.gov>

The following warnings are labels placed on affected products. If these labels are not present then they do not apply to that product.

 **WARNING:** This product can expose you to chemicals including 4-Vinylcyclohexene which is known to the State of California to cause cancer and birth defects or other reproductive harm. For more information go to www.P65Warnings.ca.gov.

4-Vinylcyclohexene label above to be used any product made with Bayblend T85

 **WARNING:** This product can expose you to chemicals including titanium dioxide, which is known to the State of California to cause cancer. For more information go to www.P65Warnings.ca.gov.

Conflict Minerals Compliance Statement

Section 1502 of the Dodd-Frank Wall Street Reform and Consumer Protection Act, and the Securities and Exchange Commission Rules adopted in connection therewith, require certain corporations to report the use of "Conflict Minerals" in the manufacture of their products. Generally, Conflict Minerals collectively refers to cassiterite, columbite-tantalite, gold, wolframite, or their derivatives, including tantalum, tin and tungsten, which originate from the Democratic Republic of the Congo or specified adjoining countries (referred to herein as "Covered Countries").

While we, as a privately held corporation, are not subject to the Conflict Minerals rules and reporting requirements, we understand that our customers may be, and we are committed to helping our customers comply with their reporting requirements. In order to determine if our manufactured products contain Conflict Minerals, we have asked our relevant suppliers, as of September 1, 2020, to ascertain their use of any Conflict Minerals in the materials they supply to us. Their responses demonstrate that our relevant suppliers (i) do not use Conflict Minerals in the materials they supply to us, (ii) have no reason to believe the Conflict Minerals they use may have originated in the Covered Countries, and/or (iii) reasonably believe that the Conflict Minerals they use are from recycled or scrap sources. Consequently, we can in turn represent that, to the best of our knowledge, our manufactured products either do not contain Conflict Minerals, or to the extent they may, such products are "DRC conflict free" as defined by paragraph (e)(4) of Section 1502.

We will continue to work with our key suppliers to ensure that we are able to identify the use of Conflict Minerals in our supply chain, and the representations made in this compliance statement remain accurate. To that end, we reserve the right to amend this statement at any time based on subsequent developments or information.

Should you have any questions or concerns regarding this statement, please do not hesitate to contact us.

FREQUENTLY ASKED QUESTIONS

COMFORT XLT™ SERIES
PH04-1000

Toilets and Restrooms

Q: Can I use a toilet unit on my own, or do I need a professional?

A: It is illegal to dispose of human waste in an improper way. You can purchase a portable toilet for your own personal use, but you will need to hire a professional portable toilet operator to empty and dispose of the waste when needed.

Q: Can any toilet unit have a sink added to the inside?

A: Not every unit can house an interior sink. The Comfort XL and We'll Care units do not have interior sinks. The Comfort XLT, PJN3, PJP3 and Fleet do have interior sinks. All Fresh Flush units require a sink to operate, but static and recirculating flush units can add a sink.

Q: How do I initially set up a portable toilet for use?

A: For each new use of an emptied tank, it needs to be charged with 5 gallons of water and a chemical often referred to as "blue" in the industry. It contains dyes and enzymes designed to break down waste.

Q: Can I replace parts on my toilet?

A: Absolutely. We offer all our parts as replacements. Just call into PolyJohn or contact your local rep to place an order.

Q: My toilet has a dump valve, can I use that to empty the waste tank?

A: You can use the dump valve to empty the tank, but it needs to be done at an RV dump station that has the proper equipment and treatment on site. You can also hire a local portable toilet operator to empty the waste tank.

Q: In my recirculating unit where does the water come that flushes the toilet bowl?

A: A recirculating unit takes the water that is inside the tank and uses it to flush the toilet bowl. Yes, it is the used water inside the tank. Do not be worried about this. There are two separate filters that filter out any solid substance before it comes to the bowl. And this water has been mixed with the powerful chemicals that break down waste inside the tank. This saves fresh water usage while still getting the benefits of flushing.

Q: How does the fresh water flush toilets work?

A: Unlike the recirculating toilets, the fresh water models require a sink. The bowl flushing mechanism draws fresh water from the sink to flush. The sink also uses the fresh water for hand washing and the gray water drains into the toilet tank.

Q: My screen broke, how do I replace it?

A: The screens can be removed and replaced by drilling out the rivets, sliding the screen out, sliding the new one in and re-riveting the screens in place.

Q: You don't have the old style urinal anymore, so will a new style work? If so, what do I need to do to modify my unit so the new urinal will fit?

A: The new PolyJohn Urinal has been completely redesigned. The new design has been proven to be the best shape and form to keep splash-back to a minimum. The side walls are much higher and there is no lip on the inside. This will help keep the urinal clean. The entire urinal has smooth surfaces as well to aid in cleaning. The new urinal can also hold 5 pounds of salt for colder climates. To help your customers who might need something to shoot for. To install the new urinal on old tanks, you will need 4 - PC-000102 Rivets, 4 - PC-000106 Washers, and 1 PC-000557 Cap.

WARRANTY

COMFORT XLT™ SERIES
PH04-1000

RESTROOMS AND TOILETS

POLYJOHN PORTABLE RESTROOMS LIMITED 3 YEAR PRODUCT WARRANTY

PolyJohn Enterprises Corp. warrants the major plastic parts of its portable restrooms (plastic front, wall panels, roof, and tank) against any breakage or other problems that prevent the PolyJohn portable toilet from functioning in accordance with usual practices used in the portable toilet industry and in their intended manner. This warranty covers any damages in material or workmanship for a total period of 3 years (36 months). This warranty extends only to the original purchaser of the PolyJohn portable restroom. Proof of purchase, serial numbers, and photos will be required.

SINKS, TANKS, TRAILERS AND SANISTANDS

PolyJohn Enterprises warrants our sinks, tanks, trailers and sanistands from the date of purchase. Any misuse or abuse of our products or failure to properly follow recommended procedures shall void this warranty. The warranty is a 1 year limited warranty and a 90 day limited warranty for components thereof.

What is Not Covered By Warranty

This warranty does not cover damage or failure contributed to or caused by: Not following PolyJohn assembly procedures, unauthorized modification, acts of God, mishandling, misuse, use of incompatible solvents or other damaging chemicals, vandalism or accident. In no event shall PolyJohn be liable for labor costs or for incidental or consequential damages.

For full details on PolyJohn's warranty policy, and to view instructions for submitting a claim please visit <https://www.polyjohn.com/warranty/>.

Warranty Disclaimer

PolyJohn's terms of sale are FOB (Free on Board Shipping Point). Meaning buyer takes on responsibility once it leaves PolyJohn's shipping dock. The carrier is wholly responsible for any damage incurred during transit. Important notice: All concealed/non-notated damages must be reported within 5 business days of delivery (1st day is the day of delivery) as per the National Motor Freight Classification (NMFC) – Rule 300100 - for a damaged claim to be filed. Reporting after this time will void a claim.

In order to prevent warranty disputes follow these steps immediately when receiving your products:

Inspect the shipment immediately and insist that visible damages be indicated on your copy of the freight bill. If they are not noted on the freight bill it is very likely a claim will be denied.

Open the shipment if necessary, and inspect for any concealed damages.

If there are any damages that you cannot operate with you may refuse shipment. After you do this contact us immediately

Filing Process for Warranty

PolyJohn reserves the right to request inspection of products for verification of defect, which may include returning some or all of the parts with shipping paid for by the purchaser. Once the items have been returned, inspected, and PolyJohn is found at fault shipping costs will be reimbursed. You may contact PolyJohn to arrange for return shipping if desired.

To file your warranty claim follow these steps:

1. Go to [polyjohn.com/warranty/](https://www.polyjohn.com/warranty/)
2. Fill out necessary contact information
3. Fill in invoice number, date of purchase, product, and product serial numbers.
4. Upload an images of affected products
5. Submit and someone will be in contact with you as soon as possible.

OUR MISSION STATEMENT

COMFORT XLT™ SERIES
PH04-1000

“PolyJohn is a family owned, state of the art, plastics manufacturing company dedicated to providing its employees with a work environment committed to excellence, and its customers with innovative products, services and technology that meet or exceed their requirements.”

THANK YOU FOR PURCHASING POLYJOHN PRODUCTS!



POLYJOHN[®]
there when you need us

POLYJOHN USA
+1 800-292-1305
Whiting, Indiana
www.polyjohn.com

POLYJOHN INTERNATIONAL
UNITED KINGDOM
+44 (0) 1937-583333
Yorkshire, England
www.polyjohn.co.uk

POLYJOHN CANADA
+1 800-465-9590
Oro Medonte, Ontario
www.polyjohn.ca
www.fr.polyjohn.ca

POLYJOHN LATIN AMERICA
+01 800-953-1307
Chihuahua, Mexico
www.polyjohn.mx

POLYJOHN AUSTRALIA
+61 7 3277 5727
Brisbane, Australia
www.totalsanitationsolutions.com.au

POLYJOHN SOUTHERN AFRICA
+27 (011) 615-3804
Johannesburg, South Africa
www.polyjohn.co.za

POLYJOHN NEW ZEALAND
+64 (0)22 387 7142
Auckland, New Zealand
www.polyjohn.co.nz

POLYJOHN SOUTH AMERICA
+57 318 696 7744
Bogotá, Colombia
www.polyjohn.com

POLYJOHN INTERNATIONAL
CZECH REPUBLIC
+420 608 876 983
Karlovy Vary, Czech Republic
www.polyjohn.eu